

# A SUMMARY OF THE KEY TECHNOLOGIES FOR METRIC RANGE EXTENSION OF ELECTRIC VEHICLES

**ABSTRACT:** Electric vehicle is a sustainable development which is capable of transforming transport sector. It is a sustainable alternative to internal combustion engine-based vehicle. Its technology is based on utilization of sustainable energy resources which are eco-friendly and replenishes in nature. Wide deployment of electric vehicle is expected to minimize the challenge of fossil fuel depletion and greenhouse emissions are expected to be reduced. However, despite all aforementioned advantages of the electric vehicle, its wide deployment faces some challenges including cost, size and range anxiety. Electric vehicles have limited range which is one of the major factors affecting its market penetration. Researchers highlighted several strategies/methods of extending its driving range. Thus, this work presents a review of different strategies proposed on range extension of the electric vehicle. The strengths and weaknesses of some of the proposed methods are also presented in this work.

*Keywords: Sustainable mobility, Range anxiety, Range extension, Hybridization, Greenhouse emission, Energy Storage system*

## 1. INTRODUCTION

Technological advancement is the bedrock of development of any nation. Human population increases on daily basis, cities are expanding and fossil fuel is depleting. Thus, there is high demand for mobility globally, leading to high vehicular density in cities. Meeting this mobility demand is instrumental to economic growth. Majority of these vehicles are powered by internal combustion engines (ICEs) and their operation is based on fossil fuel (diesel or petrol). One of the great consequences of these vehicles are traffic jams and high emission of CO<sub>2</sub>, CO, NO, etc. which has great negative impact on the eco-system, causing ozone layer depletion and leading to global warming [1] (Figure 1). Inhalation of CO<sub>2</sub> by human beings poses great danger to the health as it forms carboxy-haemoglobin in the body system which is dangerous to brain, heart and the whole body system [2]. According to International Energy Agency (IEA), transportation accounts for about 25% of the total global CO<sub>2</sub> production [3] (Figure 2). This is unsustainable. One of the measures to ensure sustainable development is the development of electric vehicles [4, 5].

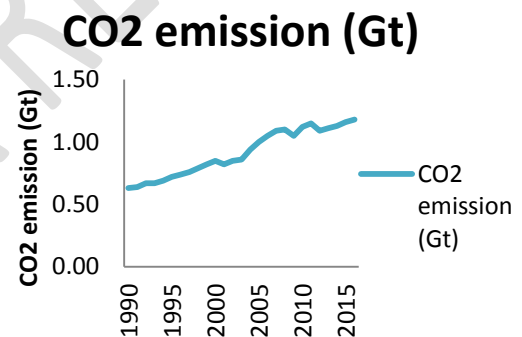

Figure 1 Carbon IV Oxide (CO<sub>2</sub>) emission by transport sector[6]

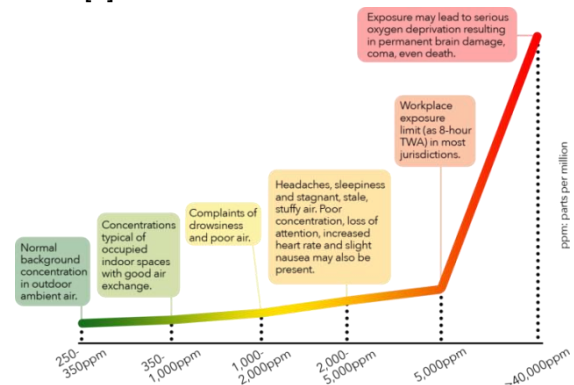

Figure 2 Benefit of reducing CO<sub>2</sub> [27]

The electric vehicle field and electro-mobility are generally prospective sectors. It is a vehicle that does not pollute the environment through tailpipe emission,

fuel refining or fuel evaporation and it is powered by high-efficiency engine [7].

Considering the environmental effect of conventional vehicles, the best alternative to ICE-based vehicle is electric vehicle powered by battery [8]. The main barriers to EV market penetration are their limited driving range, long recharging times and high cost compared to conventional vehicles powered by internal combustion engines [9]. The driving range is limited by the capacity and type of energy storage system.

There are many components and systems that make up electric vehicle (EV). One of the most important components is energy storage system (ESS)[10]. An ESS is a system that captures energy produced at a particular time and supplies it at the required time for propulsion of electric vehicle. ESSs are of different size and different configurations which sometimes determine the type of electric vehicle. Some are battery electric vehicles (BEVs), Hybrid Electric Vehicles (HEVs), etc [1].

## 2 HYBRID ENERGY STORAGE SYSTEM

Hybrid energy storage system (HESS) is a system that involves combination of two or more types of energy storage devices with electronic control to properly coordinate and optimize the system for powering electric vehicle (Figure 3). Examples include battery and ICE, ultracapacitor and battery, ultracapacitor and ICE etc.

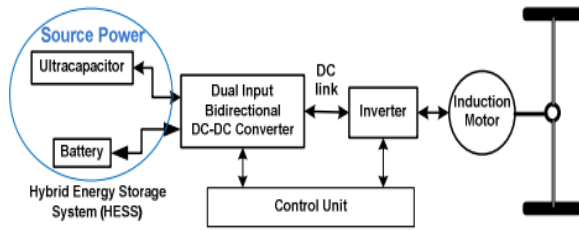

Figure 3 Block diagram of power circuit of EV with HESS

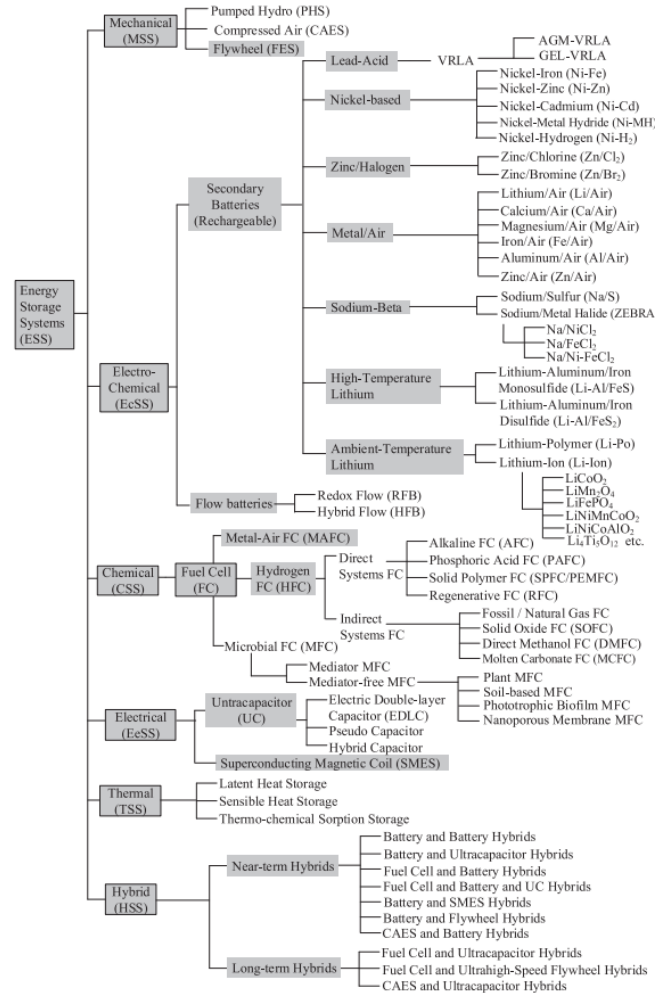

Figure 4 ESS based on composition material and energy formation [1]

In electric vehicles, rechargeable battery is the main source of energy and it is required to meet the vehicle range which depends on the capacity and the type of the battery. Therefore, one of the major factors facing universal adoption of electric vehicle is range anxiety. Drivers and car owners are battling with this challenge. Some researchers have reported techniques to extend the metric range of EVs in literature. However, the challenge is yet to be overcome [11]. The methods proposed for extension of metric range of EVs include contactless power transfer, improved storage system, use of photovoltaic resource, use of wind energy resource, thermal management, and improved driver behavior. These methods are reviewed and presented in this work.

### 3 CONTACTLESS POWER TRANSFER

Contactless Power Transfer (CPT) is regarded as the act of transferring power to an electrical load with non-physical contact. It involves coupling of coils in a mutual way resembling conventional transformers (Figure 5). The transfer of power from source to the load is magnetic over large air gap. S. Chopra and P. Bauer in [12] proposed this method for improving driving range using CPT for highway and urban driving scenarios.

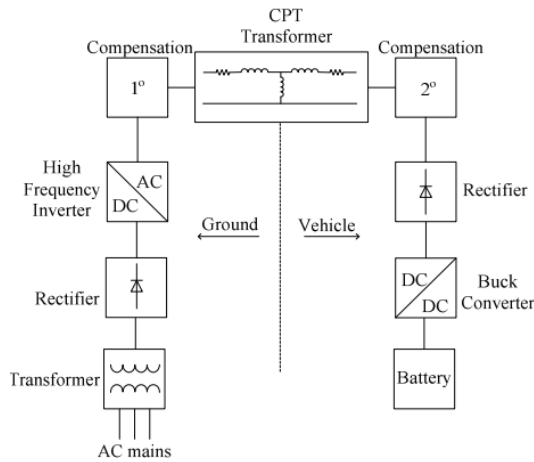

Figure 5 Structure of a CPT system

The strength of this method is that transferring power through windings that are magnetically coupled is very beneficial than systems that are contact-based because it eliminates or reduces the electrical safety risk of sparking and electric shocking which makes the system more reliable, it requires low maintenance; it simplifies charging of battery and thereby enhancing driving range of EVs. Also, [12] did not address economic feasibility of this proposed method.

### 4 IMPROVED STORAGE SYSTEM

At the wheel of any EV, the required power comprises five main components [13, 14]. These are air resistance or aerodynamic drag power, rolling resistance, required power to overcome gravity during downwards and upwards gradient of the road, required power for overcoming inertia of the vehicle and power requirement of EV electric loads like music system, air conditioning, heater, etc. The need to meet the power demand of the EVs as stated above and to improve

the driving range results in high demand for improved and optimized storage system. This can be achieved through combination of two or more sources of energy known as *hybridized energy storage system* (HESS) [15] which was stated earlier. R. M. Schupbach et al. in [16] proposed parallel combination of battery and supercapacitor for energy improvement of the EVs. Theoretically, the number of charging and discharging of ultracapacitor is infinite but can only store energy within short period of time. Therefore, the system can be designed in such a way that ultracapacitor can be made to supply the input power during fast energy burst while battery remains in a steady state operation [17] (Figure 6).

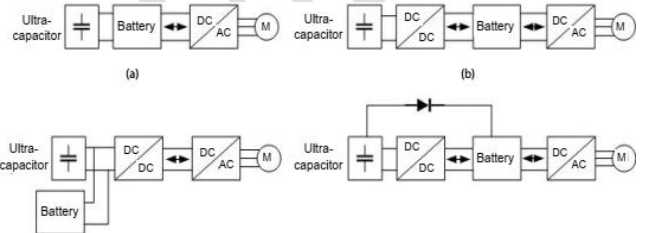

Figure 6a Direct parallel connection of ultracapacitor with battery; b Bi-directional DC-to-DC converter balancing the power flow between ultracapacitor and battery

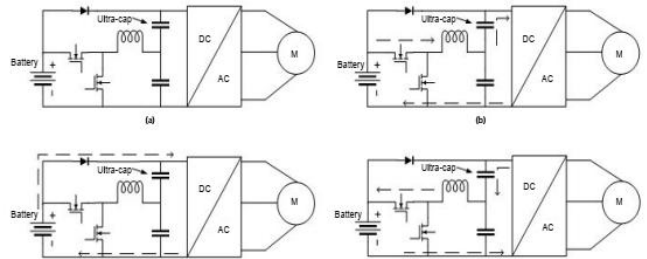

Figure 7 Hybrid energy storage using ultracapacitors (a) Basic topology (b) Battery power flow to the motor during acceleration (c) Constant speed power flow (d) Retardation power flow

The challenge in the HESS is the conduction loss of the converter during switching period, as given in (1).

$$\text{Conduction loss} = \text{switch current duty cycle} \times \text{switch on state voltage average} \quad (1)$$

Technically, to reduce these losses, different methods were proposed. Designing of optimized gate driving circuit for improvement of turn-off and turn-on speeds

of the power devices was done and led to MOSFET switching time reduction resulting in lowering switching losses. The weakness of this method is that higher speed pulses generated are on the high side which led to increase in AC voltage thereby reducing power processing efficiency.

## **5 USE OF PHOTOVOLTAIC SOURCES**

Another important method of improving range of EVs is the integration of Photovoltaic (PV) panels. It can be employed in many ways to enhance overall efficiency of the EVs. One of the strategies is PV panels deployment for charging the storage device (batteries) with a DC to DC converter while the other method is onboard electric charging i.e charging from grid due to the failure of PV to charge battery. S. De Pinto et al. in [18] proposed range improvement of EVs by using PV panel. The author simulated model of the complete PV architecture, including storage system, the DC/DC converter etc. with the help of solar irradiance profiles and recorded temperature, the model calculates the range extension of the EV in response to the PV energy input. The strength of this method is that PV can generate most of the electricity required by the vehicle as it charges battery continuously thereby significantly extending range of the EVs. However, PV sometimes fails in charging the battery which may be due to the high humidity of the cloud. This may be considered as the weakness of this method.

## **6 WIND POWER RANGE EXTENSION**

Wind power also plays important role in extending the range of EVs like that of PV. This can be achieved by connecting a small wind turbine to the EV. The motion of EV causes wind blow which can eventually charge the battery thereby resulting in range extension of the EV. The wind can be employed in two ways: it can be used as off-board charging of battery or onboard charging. It makes use of Ram air turbine coupled with generator. The energy from the movement of the vehicle is tapped for turning the turbine thereby generating energy through the help of the coupled generator. Ram air turbine (RAT) is a small wind turbine that usually serves as alternative or emergency power source.

## **7 EFFECTIVE THERMAL MANAGEMENT**

Effective thermal management is crucial to the

operational efficiency of the EVs. Climate condition has impact on the vehicle range. There is high demand for using heater during the winter period in the countries that have cold climate. Definitely, the driving range will be reduced by 50% due to the heating [19]. D. Dvorak et al. in [19] proposed strategy of optimizing energy efficiency of EVs through investigation of different thermal managements. The electronics circuits and the motor in the vehicle develop certain losses. The overall effect of heat of the vehicle can be achieved through the combination of losses and the heat flow in the car.

## **8 IMPACT OF DRIVING BEHAVIOR**

Driving range of EVs can be determined by the driving style of the drivers or car owners. It has great influence on the driving range of EVs. C. Bingham et al. in [20] investigated the effect of driving style on fuel consumption, energy storage system and driving range. It was discovered that improvement of driving range of 30% can be achieved through accurate driving style.

Some of the good driving styles are:

- i. Reducing aggression in the driving.
- ii. Reducing the difference in acceleration and deceleration.
- ii. Avoiding high accelerations.

Seamless integration of technologies like Internet of Things (IoT) in the vehicle can be employed for reduction of this impact of human behavior. In this situation, operation of the EVs with the help of sensors, the probability of errors will be minimal, thus enhancing the efficiency of the EVs.

## **9 CONCLUSION**

Electric vehicles (EVs) are a promising area capable of transforming transport sector globally. It is environmentally friendly with zero emission. However, it faces challenge of commercial market penetration due to its inherent challenge of driving range limitation. This paper presents a review of different methods of extending the metric range of EVs as proposed by researchers.

## REFERENCE

- [1] M. A. Hannan, M. M. Hoque, A. Mohamed, and A. Ayob, "Review of energy storage systems for electric vehicle applications: Issues and challenges," *Renewable and Sustainable Energy Reviews*, vol. 69, pp. 771-789, 2017.
- [2] A. E. O. Finkelstein, "Design and evaluation of a new diagnostic instrument for osmotic gradient ektacytometrie," Université Paris-Est, 2017.
- [3] G. Wager, M. P. McHenry, J. Whale, and T. Bräunl, "Testing energy efficiency and driving range of electric vehicles in relation to gear selection," *Renewable Energy*, vol. 62, pp. 303-312, 2014.
- [4] K. R. Kambly and T. H. Bradley, "Estimating the HVAC energy consumption of plug-in electric vehicles," *Journal of Power Sources*, vol. 259, pp. 117-124, 2014.
- [5] J.-Q. Li, "Battery-electric transit bus developments and operations: A review," *International Journal of Sustainable Transportation*, vol. 10, pp. 157-169, 2014.
- [6] J. G. Olivier, J. A. Peters, and G. Janssens-Maenhout, "Trends in global CO2 emissions 2012 report," 2012.
- [7] P. Guo and P. Liu, "Research on development of electric vehicles in China," in *2010 International Conference on Future Information Technology and Management Engineering*, 2010, pp. 94-96.
- [8] R. Faria, P. Moura, J. Delgado, and A. T. de Almeida, "A sustainability assessment of electric vehicles as a personal mobility system," *Energy Conversion and Management*, vol. 61, pp. 19-30, 2012.
- [9] S. B. Sherman, Z. P. Cano, M. Fowler, and Z. Chen, "Range-extending Zinc-air battery for electric vehicle," *AIMS Energy*, vol. 6, pp. 121-145, 2018.
- [10] A. Ostadi and M. Kazerani, "Optimal sizing of the battery unit in a plug-in electric vehicle," *IEEE Transactions on Vehicular Technology*, vol. 63, pp. 3077-3084, 2014.
- [11] J. Neubauer, A. Brooker, and E. Wood, "Sensitivity of battery electric vehicle economics to drive patterns, vehicle range, and charge strategies," *Journal of Power Sources*, vol. 209, pp. 269-277, 2012.
- [12] S. Chopra and P. Bauer, "On-road contactless power transfer-case study for driving range extension of EV," in *IECON 2011-37th Annual Conference of the IEEE Industrial Electronics Society*, 2011, pp. 4596-4602.
- [13] M. Abdelhamid, R. Singh, A. Qattawi, M. Omar, and I. Haque, "Evaluation of on-board photovoltaic modules options for electric vehicles," *IEEE Journal of Photovoltaics*, vol. 4, pp. 1576-1584, 2014.
- [14] W. Dib, A. Chasse, P. Moulin, A. Sciarretta, and G. Corde, "Optimal energy management for an electric vehicle in eco-driving applications," *Control Engineering Practice*, vol. 29, pp. 299-307, 2014.
- [15] A. Panday and H. O. Bansal, "A Review of Optimal Energy Management Strategies for Hybrid Electric Vehicle," *International Journal of Vehicular Technology*, vol. 2014, pp. 1-19, 2014.
- [16] R. M. Schupbach, J. C. Balda, M. Zolot, and B. Kramer, "Design methodology of a combined battery-ultracapacitor energy storage unit for vehicle power management," in *IEEE 34th Annual Conference on Power Electronics Specialist, 2003. PESC'03.*, 2003, pp. 88-93.
- [17] A. Ostadi and M. Kazerani, "A Comparative Analysis of Optimal Sizing of Battery-Only, Ultracapacitor-Only, and Battery-Ultracapacitor Hybrid Energy Storage Systems for a City Bus," *IEEE Transactions on Vehicular Technology*, vol. 64, pp. 4449-4460, 2015.
- [18] S. De Pinto, Q. Lu, P. Camocardi, C. Chatzikomis, A. Sornioti, D. Ragonese, *et al.*, "Electric vehicle driving range extension using photovoltaic panels," in *2016 IEEE Vehicle Power and Propulsion Conference (VPPC)*, 2016, pp. 1-6.
- [19] D. Dvorak, T. Bauml, D. Simic, C. Rathberger, and A. Lichtenberger, "Thermal vehicle-concept study using co-simulation for optimizing driving range," in *2015 IEEE Vehicle Power and Propulsion Conference (VPPC)*, 2015, pp. 1-6.
- [20] C. Bingham, C. Walsh, and S. Carroll, "Impact of driving characteristics on electric vehicle energy consumption and range," *IET Intelligent Transport Systems*, vol. 6, p. 29, 2012.